

SWIMMING POOL HEAT PUMP UNIT

Installation & Instruction Manual



CONTENTS

| | |
|--|----|
| 1. Preface | 1 |
| 2. Specifications | 4 |
| 2.1 Performance Data of Swimming Pool Heat Pump Unit | 4 |
| 2.2 Dimensions for Swimming Pool Heat Pump Unit | 5 |
| 3. Installation and Connection | 6 |
| 3.1 Installation illustration | 6 |
| 3.2 Swimming Pool Heat Pumps Location | 7 |
| 3.3 How Close to Your Pool? | 7 |
| 3.4 Swimming Pool Heat Pumps Plumbing | 8 |
| 3.5 Swimming Pool Heat Pumps Electrical Wiring | 9 |
| 3.6 Initial Start-up of the Unit | 9 |
| 4. Use and Operation Instruction | 10 |
| 4.1 Interface display | 10 |
| 4.2 Key and icon function instruction | 10 |
| 4.3 Startup & shutdown | 12 |
| 4.4 Mode switch | 12 |
| 4.5 Temperature setting | 13 |
| 4.6 Clock setting | 14 |
| 4.7 Silent setting | 16 |
| 4.8 Keyboard lock | 17 |
| 4.9 Fault interface | 17 |
| 4.10 Parameter list and breakdown table | 18 |
| 4.11 Main board | 21 |
| 5. Maintenance and Inspection | 22 |
| 6. Appendix | 28 |
| 6.1 Cable specification | 28 |
| 6.2 Comparison table of refrigerant saturation temperature | 29 |

1. PREFACE

- In order to provide our customers with quality, reliability and versatility, this product has been made to strict production standards. This manual includes all the necessary information about installation, debugging, discharging and maintenance. Please read this manual carefully before you open or maintain the unit. The manufacture of this product will not be held responsible if someone is injured or the unit is damaged, as a result of improper installation, debugging, or unnecessary maintenance. It is vital that the instructions within this manual are adhered to at all times. The unit must be installed by qualified personnel.
- The unit can only be repaired by qualified installer centre, personnel or an authorised dealer.
- Maintenance and operation must be carried out according to the recommended time and frequency, as stated in this manual.
- Use genuine standard spare parts only.
Failure to comply with these recommendations will invalidate the warranty.
- Swimming Pool Heat Pump Unit heats the swimming pool water and keeps the temperature constant. For split type unit, The indoor unit can be discretely hidden or semi-hidden to suit a luxury house.

Our heat pump has following characteristics:

1 Durable

The heat exchanger is made of PVC & Titanium tube which can withstand prolonged exposure to swimming pool water.

2 Installation flexibility

The unit can be installed outdoors.

3 Quiet operation

The unit comprises an efficient rotary/ scroll compressor and a low-noise fan motor, which guarantees its quiet operation.

4 Advanced controlling

The unit includes micro-computer controlling, allowing all operation parameters to be set. Operation status can be displayed on the LCD wire controller. Remote controller can be chosen as future option.

● WARNING

Do not use means to accelerate the defrosting process or to clean, Other than those recommended by the manufacturer.

The appliance shall be stored in a room without continuously operating ignition sources (for example: open flames, an operating gas appliance or an operating electric heater.)

Do not pierce or burn.

Be aware that refrigerants may not contain an odour,

Appliance shall be installed, operated and stored in a room with a floor area larger than 30 m².

NOTE The manufacturer may provide other suitable examples or may provide additional information about the refrigerant odour.



1. PREFACE

- This appliance can be used by children aged from 8 years and above and persons with reduced physical, sensory or mental capabilities or lack of experience and knowledge if they have been given supervision or instruction concerning use of the appliance in a safe way and understand the hazards involved. Children shall not play with the appliance. Cleaning and user maintenance shall not be made by children without supervision.
- If the supply cord is damaged, it must be replaced by the manufacturer, its service agent or similarly qualified persons in order to avoid a hazard.
- The appliance shall be installed in accordance with national wiring regulations.
- Do not operate your air conditioner in a wet room such as a bathroom or laundry room.
- Before obtaining access to terminals, all supply circuits must be disconnected.
- An all-pole disconnection device which has at least 3mm clearances in all poles, and have a leakage current that may exceed 10mA, the residual current device (RCD) having a rated residual operating current not exceeding 30mA, and disconnection must be incorporated in the fixed wiring in accordance with the wiring rules.
- Do not use means to accelerate the defrosting process or to clean, other than those recommended by the manufacturer
- The appliance shall be stored in a room without continuously operating ignition sources (for example: open flames, an operating gas appliance or an operating electric heater.)
- Do not pierce or burn
- Appliance shall be installed, operated and stored in a room with a floor area larger than 30 m²
 - Be aware that refrigerants may not contain an odour.
 - The installation of pipe-work shall be kept to a minimum 30 m²
 - Spaces where refrigerant pipes shall be compliance with national gas regulations.
 - Servicing shall be performed only as recommended by the manufacturer.
 - The appliance shall be stored in a well-ventilated area where the room size corresponds to the room area as specified for operation.
 - All working procedure that affets safety means shall only be carried by competent persons.
- Transport of equipment containing flammable refrigerants
 - Compliance with the transport regulations
 - Marking of equipment using signs
 - Compliance with local regulations
 - Disposal of equipment using flammable refrigerants
 - Compliance with national regulations
 - Storage of equipment/appliances
 - The storage of equipment should be in accordance with the manufacturer's instructions.
 - Storage of packed (unsold) equipment
 - Storage package protection should be constructed such that mechanical damage to the equipment inside the package will not cause a leak of the refrigerant charge.
 - The maximum number of pieces of equipment permitted to be stored together will be determined by local regulations.

1. PREFACE

Caution & Warning

1. The unit can only be repaired by qualified installer centre personnel or an authorised dealer. (for Europe market)
2. This appliance is not intended for use by persons (including children) with reduced physical sensory or mental capabilities, or lack of experience and knowledge, unless they have been given supervision or instruction concerning use of the appliance by a person responsible for their safety. (for Europe market)
Children should be supervised to ensure that they do not play with the appliance.
3. Please make sure that the unit and power connection have good earthing, otherwise may cause electrical shock.
4. If the supply cord is damaged, it must be replaced by the manufacturer or our service agent or similarly qualified person in order to avoid a hazard.
5. Directive 2002/96/EC (WEEE):
The symbol depicting a crossed-out waste bin that is underneath the appliance indicates that this product, at the end of its useful life, must be handled separately from domestic waste, must be taken to a recycling centre for electric and electronic devices or handed back to the dealer when purchasing an equivalent appliance.
6. Directive 2002/95/EC (RoHs): This product is compliant with directive 2002/95/EC (RoHs) concerning restrictions for the use of harmful substances in electric and electronic devices.
7. The unit CANNOT be installed near the flammable gas. Once there is any leakage of the gas , fire can be occur.
8. Make sure that there is circuit breaker for the unit, lack of circuit breaker can lead to electrical shock or fire.
9. The heat pump located inside the unit is equipped with an over-load protection system. It does not allow for the unit to start for at least 3 minutes from a previous stoppage.
10. The unit can only be repaired by the qualified personnel of an installer center or an authorized dealer. (for North America market)
11. Installation must be performed in accordance with the NEC/CEC by authorized person only. (for North America market)
12. USE SUPPLY WIRES SUITABLE FOR 75°C.
13. Caution: Single wall heat exchanger, not suitable for potable water connection.

2.SPECIFICATION

2.1 Performance data of Swimming Pool Heat Pump Unit

*** REFRIGERANT : R32

| UNIT | | PASRW 030-P-BP6II | PASRW 040-P-BP6II | PASRW 050-P-BP6II |
|---|-------------------|------------------------------|-------------------|-------------------|
| Rated Heating Capacity (27°C/24.3°C) | kW | 1.970~11.66 | 3.25~16.00 | 3.50~18.70 |
| | Btu/h | 6698~39644 | 11050-54400 | 11900-63580 |
| Rated Heating Power Input | kW | 0.160~2.000 | 0.30-2.91 | 0.32-3.65 |
| COP | | 12.57-5.840 | 10.83-5.50 | 10.94-5.12 |
| Rated Heating Capacity (15°C/12°C) | kW | 1.790~8.620 | 2.55-12.60 | 2.55-14.00 |
| | Btu/h | 6086~29308 | 8670-42840 | 8670-47600 |
| Rated Heating Power Input | kW | 0.290~1.910 | 0.44-2.80 | 0.47-3.24 |
| COP | | 6.170-4.520 | 5.80-4.50 | 5.43-4.32 |
| Power Supply | | 220-240V~/50Hz | 220-240V~/50Hz | 220-240V~/50Hz |
| Compressor Quantity | | 1 | 1 | 1 |
| Compressor | | Rotary | Rotary | Rotary |
| Fan Quantity | | 1 | 1 | 1 |
| Fan Rotate Speed | RPM | 800 | 750 | 750 |
| Noise | dB(A) | 42-53 | 43-54 | 43-55 |
| Water Connection | mm | 50 | 50 | 50 |
| Water Flow Volume | m ³ /h | 3.7 | 5.2 | 6.0 |
| Water Pressure Drop(max) | kPa | 4.0 | 5.0 | 5.0 |
| Unit Net Dimensions(L/W/H) | mm | See the drawing of the units | | |
| Unit Ship Dimensions(L/W/H) | mm | See package lable | | |
| Net Weight | kg | see nameplate | | |
| Shipping Weight | kg | see package label | | |

Heating: Outdoor air temp: 27°C/24.3°C, Inlet water temp:26°C

Outdoor air temp: 15°C/12°C, Inlet water temp:26°C

Operating range:

Ambient temperature:-5—43°C

Water temperature:9-40°C

2.SPECIFICATION

2.2 The dimensions for Swimming Pool Heat Pump Unit

Model: PASRW 030-P-BP6II

unit: mm

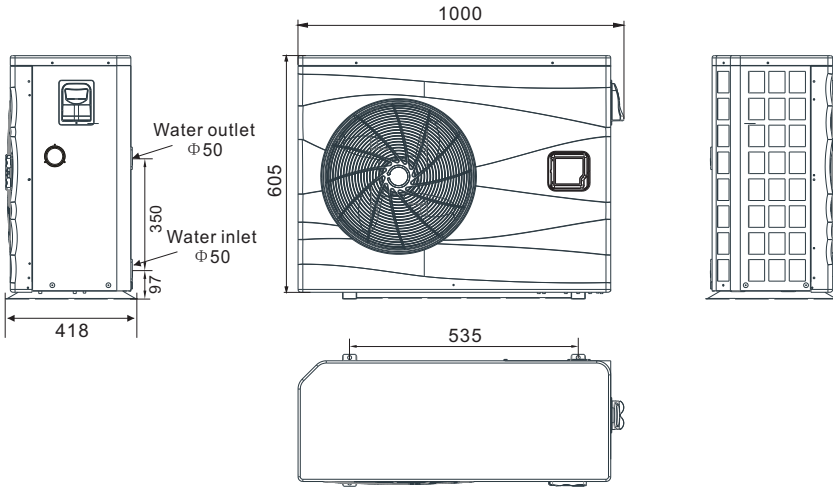

Model: PASRW 040-P-BP6II

unit: mm

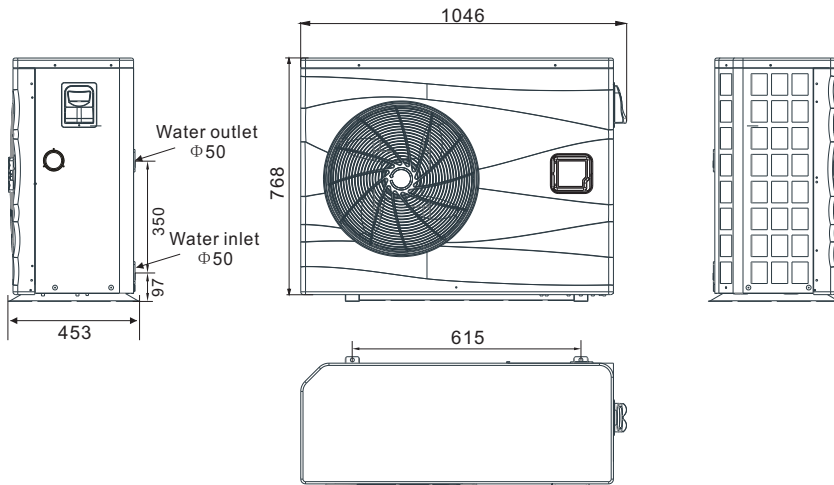

2.SPECIFICATION

2.2 The dimensions for Swimming Pool Heat Pump Unit

Model: PASRW 050-P-BP6II

unit: mm

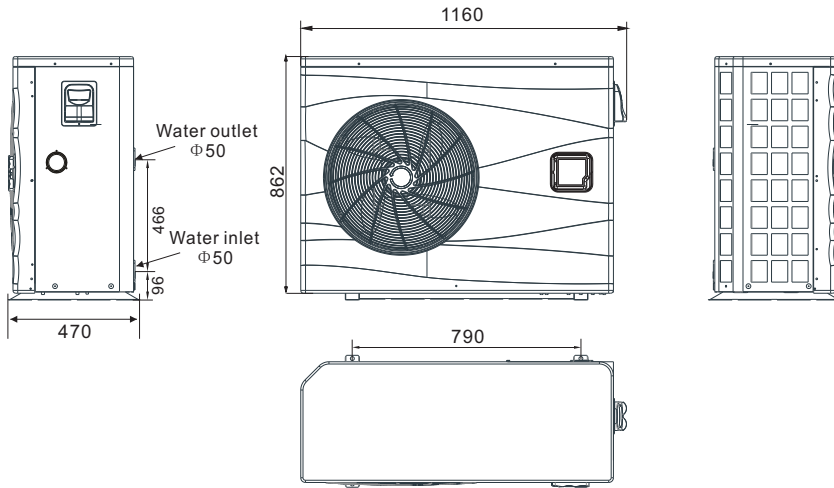

3.INSTALLATION AND CONNECTION

3.1 Installation illustration

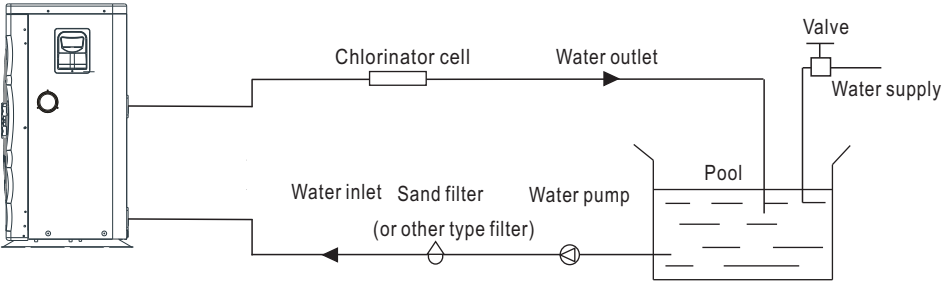

Installation items:

The factory only provides the main unit and the water unit; the other items in the illustration are necessary spare parts for the water system, that provided by users or the installer.

Attention:

Please follow these steps when using for the first time

1. Open valve and charge water.
2. Make sure that the pump and the water-in pipe have been filled with water.
3. Close the valve and start the unit.

ATTN: It is necessary that the water-in pipe is higher than the pool surface.

The schematic diagram is for reference only. Please check the water inlet/outlet label on the heat pump while plumbing installation.

The schematic diagram is for reference only. Please check the water inlet/outlet label on the heat pump while plumbing installation.

The controller is mounted on the wall

3. INSTALLATION AND CONNECTION

3.2 Swimming Pool Heat Pumps Location

The unit will perform well in any outdoor location provided that the following three factors are presented:

1. Fresh Air -
2. Electricity -
3. Pool filter piping

The unit may be installed virtually anywhere outdoors. For indoor pools please consult the supplier. Unlike a gas heater, it has no draft or pilot light problem in a windy area.

DO NOT place the unit in an enclosed area with a limited air volume, where the units discharge air will be re-circulated.

DO NOT place the unit to shrubs which can block air inlet. These locations deny the unit of a continuous source of fresh air which reduces its efficiency and may prevent adequate heat delivery.

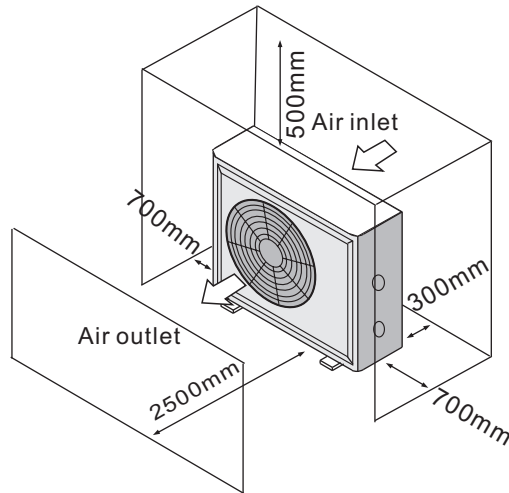

3.3 How Close To Your Pool?

Normally, the pool heat pump is installed within 7.5 metres of the pool. The longer the distance from the pool, the greater the heat loss from the piping. For the most part, the piping is buried. Therefore, the heat loss is minimal for runs of up to 15 meters (15 meters to and from the pump = 30 meters total), unless the ground is wet or the water table is high. A very rough estimate of heat loss per 30 meters is 0.6 kW-hour, (2000BTU) for every 5 °C difference in temperature between the pool water and the ground surrounding the pipe, which translates to about 3% to 5% increase in run time.

3. INSTALLATION AND CONNECTION

3.4 Swimming Pool Heat Pumps Plumbing

The Swimming Pool Heat Pumps exclusive rated flow titanium heat exchanger requires no special plumbing arrangements except bypass (please set the flow rate according to the nameplate). The water pressure drop is less than 10kPa at max. Flow rate. Since there is no residual heat or flame Temperatures, The unit does not need copper heat sink piping. PVC pipe can be run straight into the unit.

Location: Connect the unit in the pool pump discharge (return) line downstream of all filter and pool pumps, and upstream of any chlorinators, ozonators or chemical pumps.

Standard model have slip glue fittings which accept 32mm or 50 mm PVC pipe for connection to the pool or spa filtration piping. By using a 50 NB to 40NB you can plumb 40NB

Give serious consideration to adding a quick coupler fitting at the unit inlet and outlet to allow easy draining of unit for winterizing and to provide easier access should servicing be required.

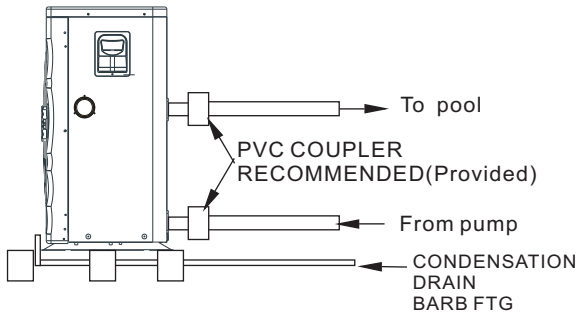

Condensation: Since the Heat pump cools down the air about 4 -5°C, water may condense on the fins of the horseshoe shaped evaporator. If the relative humidity is very high, this could be as much as several litres an hour. The water will run down the fins into the basepan and drain out through the barbed plastic condensation drain fitting on the side of the basepan. This fitting is designed to accept 20mm clear vinyl tubing which can be pushed on by hand and run to a suitable drain. It is easy to mistake the condensation for a water leak inside the unit.

NB: A quick way to verify that the water is condensation is to shut off the unit and keep the pool pump running. If the water stops running out of the basepan, it is condensation. AN EVEN QUICKER WAY IS to TEST THE DRAIN WATER FOR CHLORINE - if there is no chlorine present, then it's condensation.

3. INSTALLATION AND CONNECTION

3.5 Swimming Pool Heat Pumps Electrical Wiring

NOTE: Although the unit heat exchanger is electrically isolated from the rest of the unit, it simply prevents the flow of electricity to or from the pool water. Grounding the unit is still required to protect you against short circuits inside the unit. Bonding is also required.

The unit has a separate molded-in junction box with a standard electrical conduit nipple already in place. Just remove the screws and the front panel, feed your supply lines in through the conduit nipple and wire-nut the electric supply wires to the three connections already in the junction box (four connections if three phase). To complete electrical hookup, connect Heat Pump by electrical conduit, UF cable or other suitable means as specified (as permitted by local electrical authorities) to a dedicated AC power supply branch circuit equipped with the proper circuit breaker, disconnect or time delay fuse protection.

Disconnect - A disconnect means (circuit breaker, fused or un-fused switch) should be located within sight of and readily accessible from the unit. This is common practice on commercial and residential air conditioners and heat pumps. It prevents remotely-energizing unattended equipment and permits turning off power at the unit while the unit is being serviced.

3.6 Initial startup of the Unit

NOTE- In order for the unit to heat the pool or spa, the filter pump must be running to circulate water through the heat exchanger.

Start up Procedure - After installation is completed, you should follow these steps:

1. Turn on your filter pump. Check for water leaks and verify flow to and from the pool.
2. Turn on the electrical power supply to the unit, then press the key ON/OFF of wire controller, It should start in several seconds.
3. After running a few minutes make sure the air leaving the top(side) of the unit is cooler (Between 5-10 °C)
4. With the unit operating turn the filter pump off. The unit should also turn off automatically,
5. Allow the unit and pool pump to run 24 hours per day until desired pool water temperature is reached. When the water-in temperature reaches this setting, the unit will slow down for a period of time, if the temperature is maintained for 45 minutes the unit will turn off. The unit will now automatically restart (as long as your pool pump is running) when the pool temperature drops more than 0.2 below set temperature.

Time Delay- The unit is equipped with a 3 minute built-in solid state restart delay included to protect control circuit components and to eliminate restart cycling and contactor chatter. This time delay will automatically restart the unit approximately 3 minutes after each control circuit interruption. Even a brief power interruption will activate the solid state 3 minute restart delay and prevent the unit from starting until the 5 minute countdown is completed.







4. Use and Operation Instruction

4.1. Interface display

























4.2. Key and icon function instruction

2.1 Key function instruction

| Key symbols | Designation | Function |
|---|-------------|---|
|  | Mute key | Under the heating mode or heating mode under the automatic mode, the mute key operation is effective and used to enter and exit the mute mode with one click. |
|  | Mode key | It is used to switch the unit mode, temperature setting, and parameter setting. |
|  | On-off key | It is used to carry out startup & shutdown, cancel current operation, and return to the last level of operation. |
|  | Up key | It is used to page up, and increase variable value. |
|  | Down key | It is used to page down, and decrease variable value. |
|  | Clock key | It is used as user clock, and to carry out timing setting. |

4. Use and Operation Instruction

2.2. Icon function instruction

| Icon symbol | Designation | Function |
|---|---------------------------|--|
|  | Cooling symbol | It will display during cooling (there is no limit to startup & shutdown, and it is optional when the unit is cooling-only unit or heating-and-cooling unit). |
|  | Heating symbol | It will display during heating (there is no limit to startup & shutdown, and it is optional when the unit is heating-only unit or heating-and-cooling unit). |
|  | Automatic symbol | It will display under the automatic mode (there is no limit to startup & shutdown, and it is optional when the unit is heating-and-cooling unit). |
|  | Defrosting symbol | It will display in the defrosting process of the unit. |
|  | Compressor symbol | It will display when compressor is started. |
|  | Water pump symbol | It will display when water pump is started. |
|  | Fan symbol | It will display when fan is started. |
|  | Mute symbol | When the timing mute function is started, it keeps bright for a long time. When it is in mute state, it will flash. Or else, it is off. |
|  | Timing symbol | It will display after the user sets the timing, and multiple timing intervals can be set . |
|  | Water outlet symbol | When the axillary display area displays the water outlet temperature, the light is on. |
|  | Water inlet symbol | When the main display area displays the water inlet temperature, the light is on. |
|  | Locking key symbol | When the keyboard is locked, it is on. |
|  | Fault symbol | In case of unit fault, it is on. |
|  | Wireless signal symbol | When the unit is connected to WIFI module, it will display according to the strength of WIFI signal. |
|  | Degrees Celsius symbol | When main display area or auxiliary display area displays degrees Celsius, it is on. |
|  | Degrees Fahrenheit symbol | When main display area or auxiliary display area displays degrees Fahrenheit, it is on. |
|  | Setting symbol | When the parameter is adjustable, it is on |
|  | Second symbol | When main display area displays second digit, it is on. |
|  | Minute symbol | When main display area displays minute digit, it is on. |
|  | Hour symbol | When main display area displays hour digit, it is on. |
|  | Pressure symbol | When main display area displays pressure, it is on. |
|  | Flow symbol | When main display area displays flow, it is on. |

4. Use and Operation Instruction

4.3. Startup & shutdown

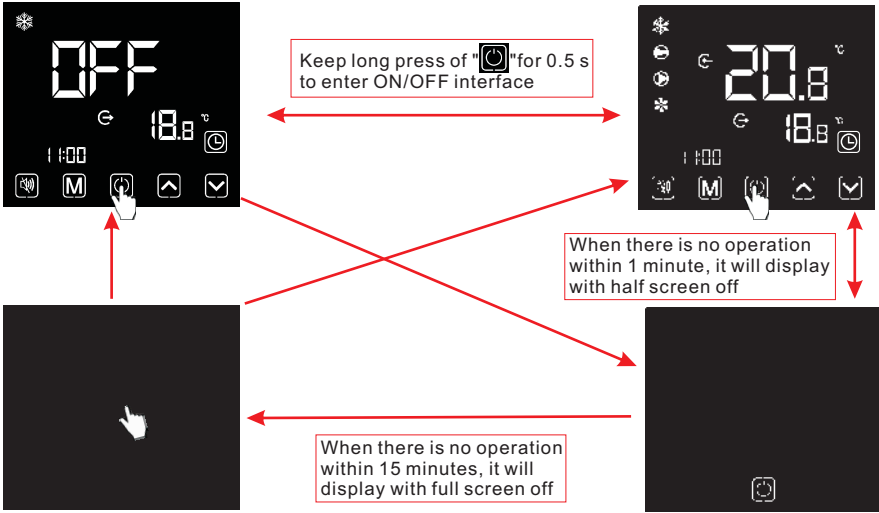

Notes:

Startup & shutdown operation can only be conducted in the main interface.

When it displays with half screen off or full screen off, click any key for returning to ON/OFF main interface.

When the unit is started under the control of wire controller, if using the emergency switch to shut down, the wire controller will display as follows:

Operations are the same as under ON/OFF main interface.



4.4. Mode switch

Under the main interface, Short press "M" to switch the unit among heating "☀️", cooling "❄️" and automatic mode "🏠".

4. Use and Operation Instruction

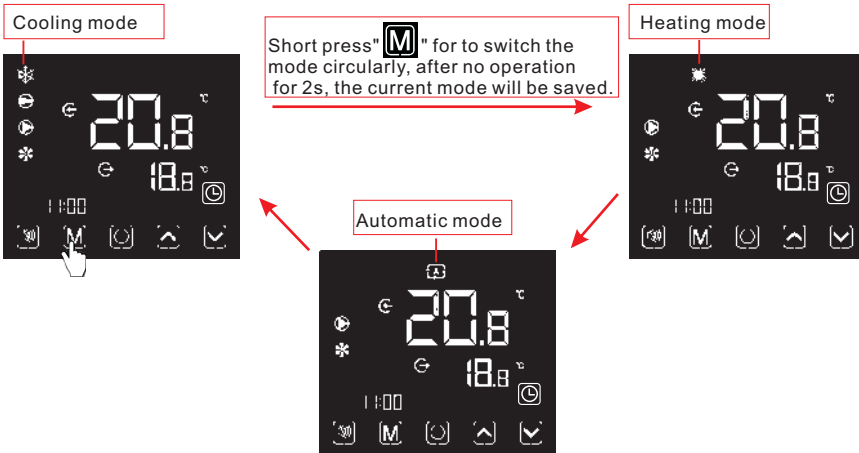

Operation descriptions:

- 1). Mode switch operation can only be conducted in the main interface.
- 2). When the unit is under the defrosting state, the defrosting symbol is on, with the display interface as follows:



Notes:

- 1). After completing the defrosting, the unit will be automatically switched to the heating/automatic mode (keeping consistent with the mode before defrosting). During the defrosting, mode switch is available. And when switching the mode, the unit won't work under a new mode until defrosting is completed.

4.5. Temperature setting

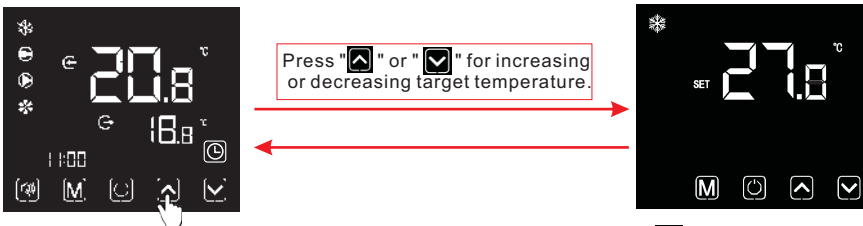

Notes: Under the temperature setting interface, if short press "⏻", the system will return to the main interface without any changes saved; If there is no operation for 5 s or short press "M", the current mode will be saved, and return to the main interface.

4. Use and Operation Instruction

4.6. Clock setting

6.1 System time setting

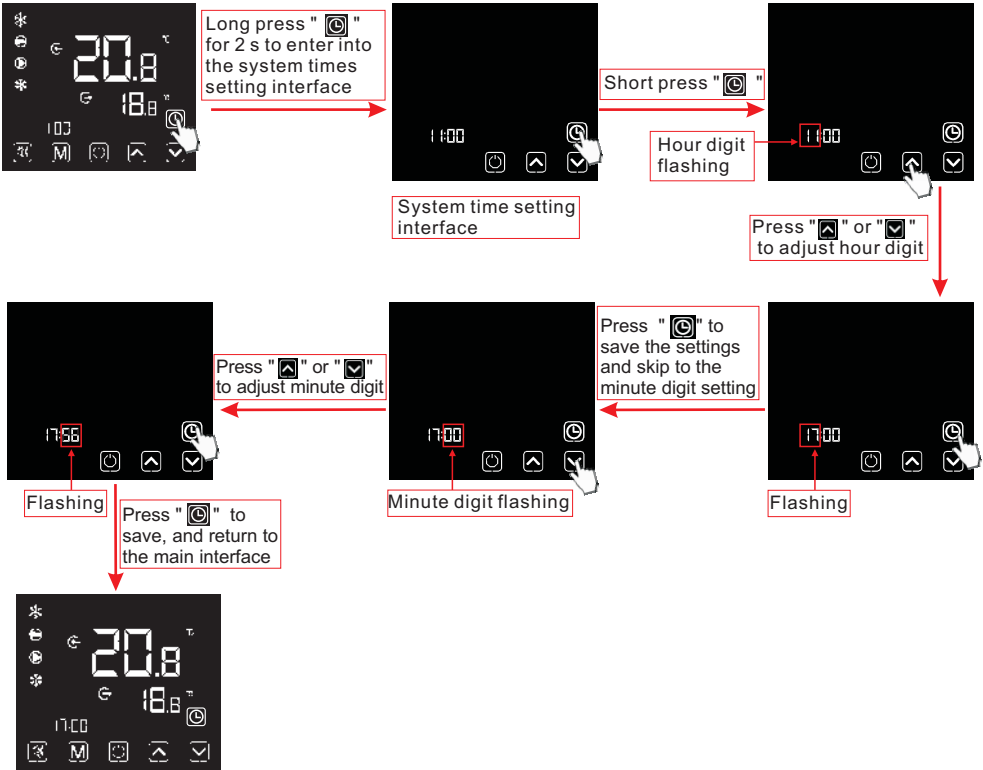

Notes: Under the clock setting interface, if there is no operation for 20 s, the system will automatically memorize use's settings, and return to the main interface; if short press "⌚" during any operating steps, the changes will not be saved and return to the main interface.

6.2 Setting and cancelling the Timer ON/OFF function

6.2.1 The wire controller can set up a two-stage timing switch: Timer ON1~ OFF1;Timer ON2~OFF2.

6.2.2 Select "On¹", "OFF1", "On²" or "OFF²" timer setting interface:

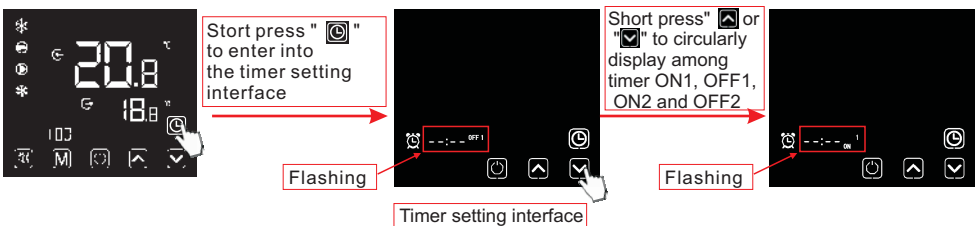

4. Use and Operation Instruction

6.2.3 Setting the Timer ON/OFF function

While enter into the "ON1", "OFF1", "ON2" or "OFF2" timer setting interface, set the Timer ON/OFF as below:

* Take ON1 for example:

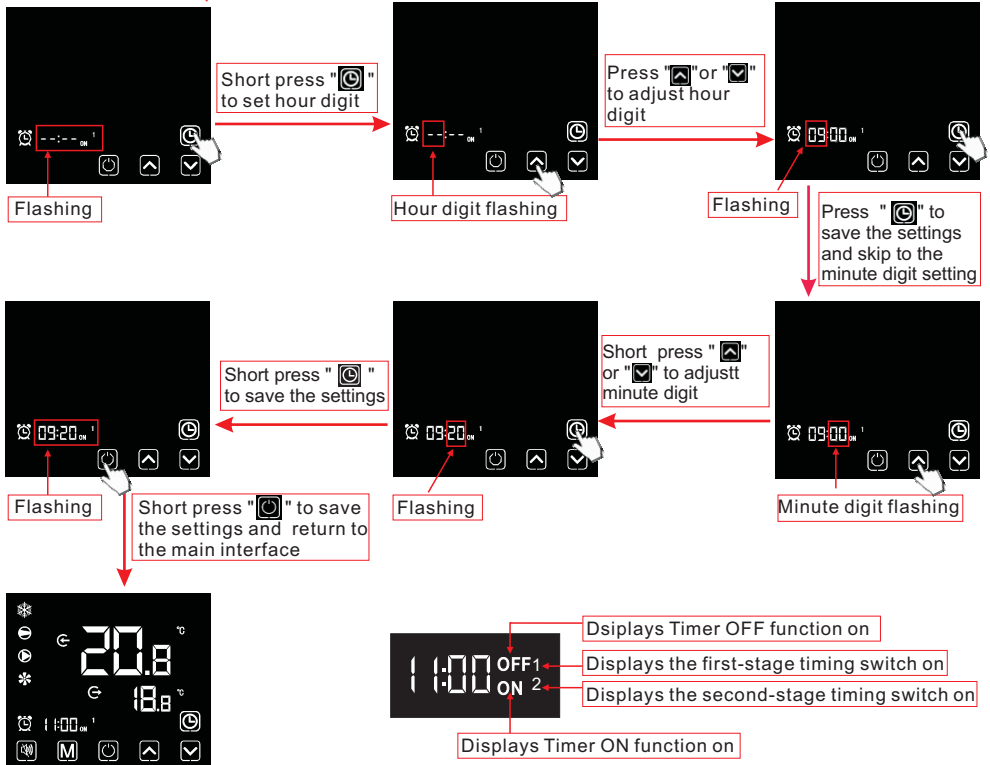

6.2.4 Cancelling the Timer ON/OFF function

1) Select "ON1", "OFF1", "ON2" or "OFF2" timer setting interface refers to 6.2.1, cancel the Timer ON/OFF as below:

* Take ON1 for example:

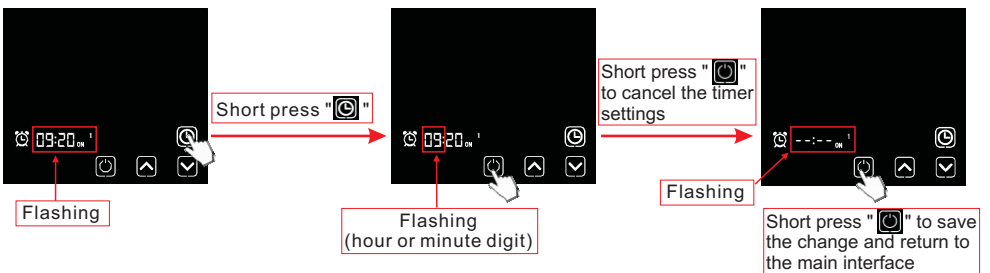

- 2) To cancel the first-stage timing switch: cancel both "ON1" and "OFF1";
- To cancel the second-stage timing switch: cancel both "ON2" and "OFF2";
- To cancel the two stage timing switch: cancel all "ON1", "OFF1", "ON2" and "OFF2".

Note: Under the Timer ON/OFF setting interface, if the timing symbol and entire time digits flash at the same time, click "[Power]" to return to the main interface;

4. Use and Operation Instruction

4.7. Silent setting

7.1 One-click silent function

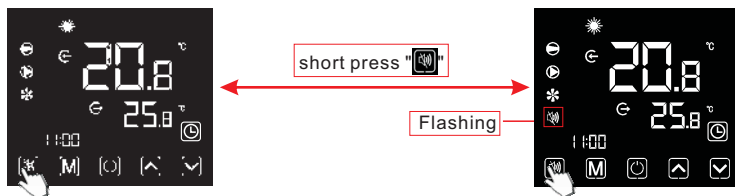

Notes:

- 1). If one-click silent and timing silent are started at the same time, short press "🔇" for canceling one-click silent and quitting the timing silent for this time.
- 2). At night or the rest time, user can start one-click silent or timing silent function to reduce the noise.

7.2 Setting and cancelling the silent function

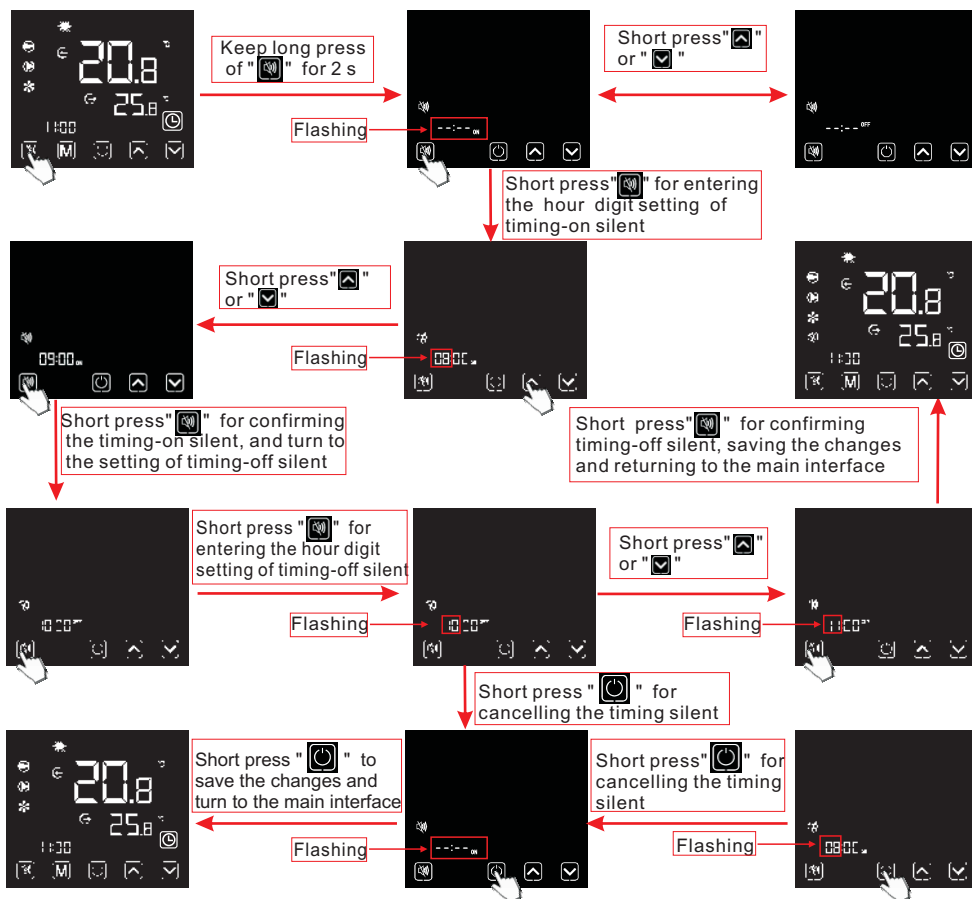

4. Use and Operation Instruction

Notes:

- 1). When the silent icon "🔇" is lightened: The timing mute has been set, but it's not under silent status.
- 2). When the silent icon "🔇" flash: It's under the silent status.
- 3). When the silent icon "🔇" disappear: The timing silent is not set.

4.8. Keyboard lock

To avoid others' misoperation, please lock the wire controller after completing the setting.

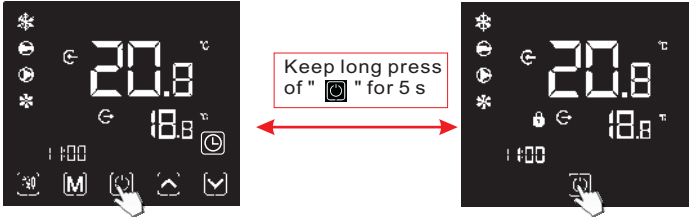

Notes:

- 1). Under the locked screen interface, only unlocking operation is available, and the screen will be lightened after other operations conducted.
- 2). Under the OFF interface, locking operation is available, and the operation method is the same as locking screen under the ON interface.

4.9. Fault interface

When the unit fails, the wire controller can display the corresponding code according to the fault reason. Refer to the fault table for the specific definition of the fault codes.

For example:

1). Single fault:

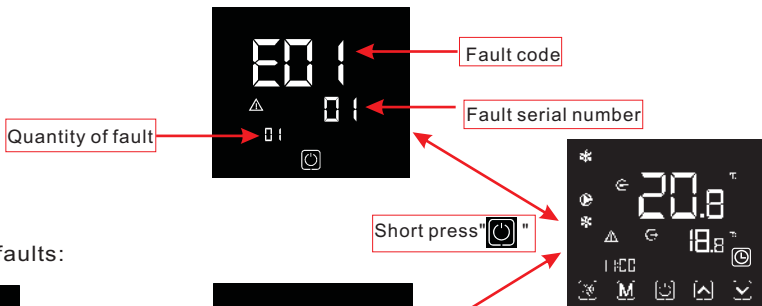

2). Two or more faults:

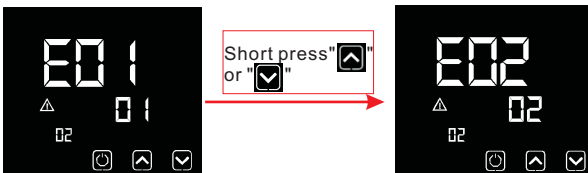

Remark:

The wire controller can display the temperature unit as "F" or "C" according to the unit model you bought.

4. Use and Operation Instruction

4.10 . Parameter list and breakdown table

10.1 Electronic control fault table

Can be judged according to the remote controller failure code and troubleshooting

| Protect/fault | Fault display | Reason | Elimination methods |
|--|---------------|--|---|
| Inlet Temp. Sensor Fault | P01 | The temp. Sensor is broken or short circuit | Check or change the temp. Sensor |
| Outlet Temp. Sensor Fault | P02 | The temp. Sensor is broken or short circuit | Check or change the temp. Sensor |
| Amibent Temp. Sensor Fault | P04 | The temp. Sensor is broken or short circuit | Check or change the temp. Sensor |
| Coil 1 Temp. Sensor Fault | P05 | The temp. Sensor is broken or short circuit | Check or change the temp. Sensor |
| Coil 2 Temp. Sensor Fault | P15 | The temp. Sensor is broken or short circuit | Check or change the temp. Sensor |
| Suction Temp. Sensor Fault | P07 | The temp. Sensor is broken or short circuit | Check or change the temp. Sensor |
| Discharge Temp. Sensor Fault | P081 | The temp. Sensor is broken or short circuit | Check or change the temp. Sensor |
| Exhaust Air over Temp Prot. | P082 | The compressor is overload | Check whether the system of the compressor running normally |
| Antifreeze Temp. Sensor Fault | P09 | Antifreeze temp sensor is broken or short circuited | check and replace this temp sensor |
| Pressure sensor Fault | PP | The pressure Sensor is broken | Check or change the pressure Sensor or pressure |
| High Pressure Prot. | E01 | The high-preesure switch is broken | Check the pressure switch and cold circuit |
| Low Pressure Prot. | E02 | Low pressure1 protection | Check the pressure switch and cold circuit |
| Flow Switch Prot. | E03 | No water/little water in water system | Check the pipe water flow and water pump |
| Waterway Anti-freezing Prot. | E05 | Water temp.or ambient temp. is too low | |
| Inlet and outlet temp. too big | E06 | Water flow is not enough and low differential pressure | Check the pipe water flow and whether water system is jammed or not |
| Anti-freezing Prot. | E07 | Water flow is not enough | Check the pipe water flow and whether water system is jammed or not |
| Winter Primary Anti-freezing Prot. | E19 | The ambient temp. is low in winter | |
| Winter Secondary Anti-freezing Prot. | E29 | The ambient temp. is low in winter | |
| Comp. Overcurrent Prot. | E051 | The compressor is overload | Check whether the system of the compressor running normally |
| Communication Fault | E08 | Communicat ion failure between wire controller and mainboard | Check the wire connection between remote wire controller and main board |
| Communication Fault (speed control module) | E081 | Speed control module and main board communication fail | Check the communication connection |
| Low AT Protection | TP | Ambient temp is too low | |
| EC fan feedback Fault | F051 | There is something wrong with fan motor and fan motor stops running | Check whether fan motor is broken or locked or not |
| Fan Motor1 Fault | F031 | 1. Motor is in locked-rotor state 2.The wire connection between DC-fan motor module and fan motor is in bad contact | 1. Change a new fan motor 2.Check the wire connection and make sure they are in good contact |

4. Use and Operation Instruction

| | | | |
|--|------|---|--|
| Fan Motor2 Fault | F032 | 1. Motor is in locked-rotor state 2. The wire connection between DC-fan motor module and fan motor is in bad contact | 1. Change a new fan motor 2. Check the wire connection and make sure they are in good contact |
| Communication Fault (speed control module) | E081 | Speed control module and main board communication fail | Check the communication connection |

Frequency conversion board fault table:

| Protection/fault | Fault display | Reason | Elimination methods |
|------------------------------|---------------|--|---|
| Drv1 MOP alarm | F01 | MOP drive alarm | Recovery after the 150s |
| Inverter offline | F02 | Frequency conversion board and main board communication failure | Check the communication connection |
| IPM protection | F03 | IPM modular protection | Recovery after the 150s |
| Comp. Driver Failure | F04 | Lack of phase, step or drive hardware damage | Check the measuring voltage check frequency conversion board hardware |
| DC Fan Fault | F05 | Motor current feedback open circuit or short circuit | Check whether current return wires connected motor |
| IPM Overcurrent | F06 | IPM Input current is large | Check and adjust the current measurement |
| Inv. DC Overvoltage | F07 | DC bus voltage > Dc bus over-voltage protection value | Check the input voltage measurement |
| Inv. DC Lessvoltage | F08 | DC bus voltage < Dc bus over-voltage protection value | Check the input voltage measurement |
| Inv. Input Lessvolt. | F09 | The input voltage is low, causing the input current is high | Check the input voltage measurement |
| Inv. Input Overvolt. | F10 | The input voltage is too high, more than outage protection current RMS | Check the input voltage measurement |
| Inv. Sampling Volt. | F11 | The input voltage sampling fault | Check and adjust the current measurement |
| Comm. Err DSP-PFC | F12 | DSP and PFC connect fault | Check the communication connection |
| Input Over Cur. | F26 | The equipment load is too large | |
| PFC fault | F27 | The PFC circuit protection | Check the PFC switch tube short circuit or not |
| IPM Over heating | F15 | The IPM module is overheat | Check and adjust the current measurement |
| Weak Magnetic Warn | F16 | Compressor magnetic force is not enough | |
| Inv. Input Out Phase | F17 | The input voltage lost phase | Check and measure the voltage adjustment |
| IPM Sampling Cur. | F18 | IPM sampling electricity is fault | Check and adjust the current measurement |
| Inv. Temp. Probe Fail | F19 | Sensor is short circuit or open circuit | Inspect and replace the sensor |
| Inverter Overheating | F20 | The transducer is overheat | Check and adjust the current measurement |
| Inv. Overheating Warn | F22 | Transducer temperature is too high | Check and adjust the current measurement |
| Comp. OverCur. Warn | F23 | Compressor electricity is large | The compressor over-current protection |
| Input Over Cur. Warn | F24 | Input current is too large | Check and adjust the current measurement |
| EEPROM Error Warn | F25 | MCU error | Check whether the chip is damaged Replace the chip |
| V15V over/undervoltage fault | F28 | The V15V is overload or undervoltage | Check the V15V input voltage in range 13.5v~16.5v or not |

4. Use and Operation Instruction

10.2 Parameter list

| Meaning | Default | Remarks |
|--|---------|------------|
| Refrigeration target temperature set point | 27°C | Adjustable |
| Heating the target temperature set point | 27°C | Adjustable |
| Automatic target temperature set point | 27°C | Adjustable |

4. Use and Operation Instruction

4.11 . Main board(PASRW 030-P-BP6II) Controller interface diagram and definition

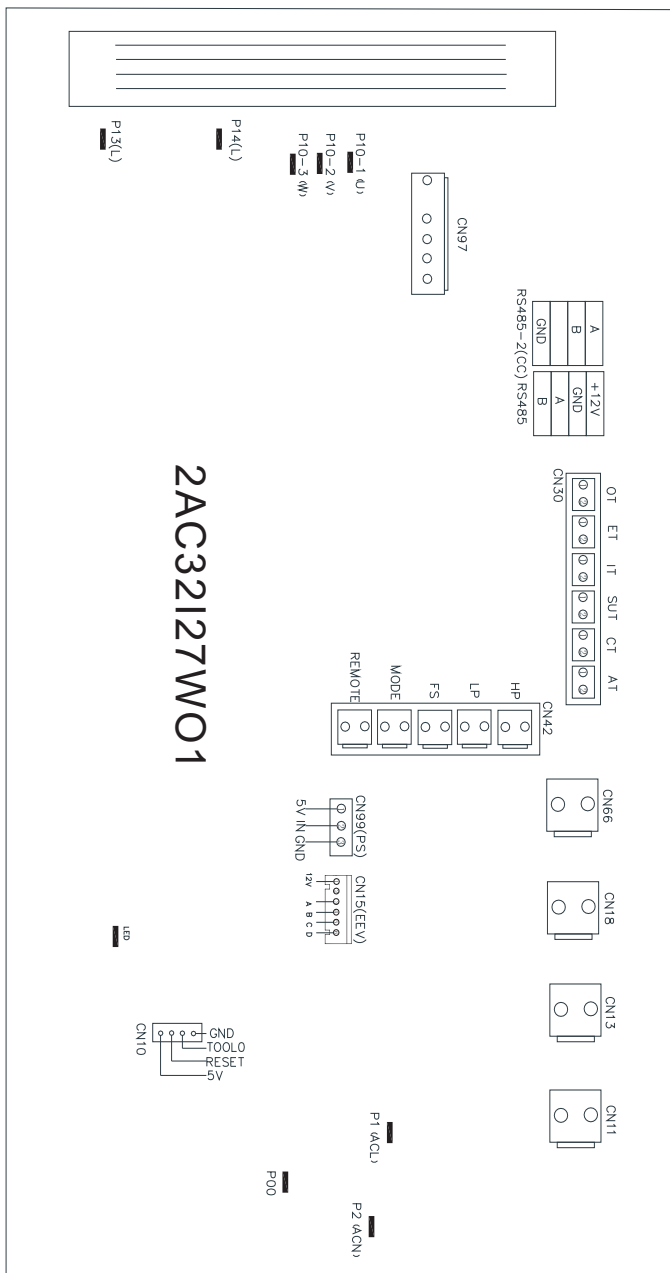

4. Use and Operation Instruction

4.11 . Main board(PASRW 040-P-BP6II,PASRW 050-P-BP6II) Controller interface diagram and definition

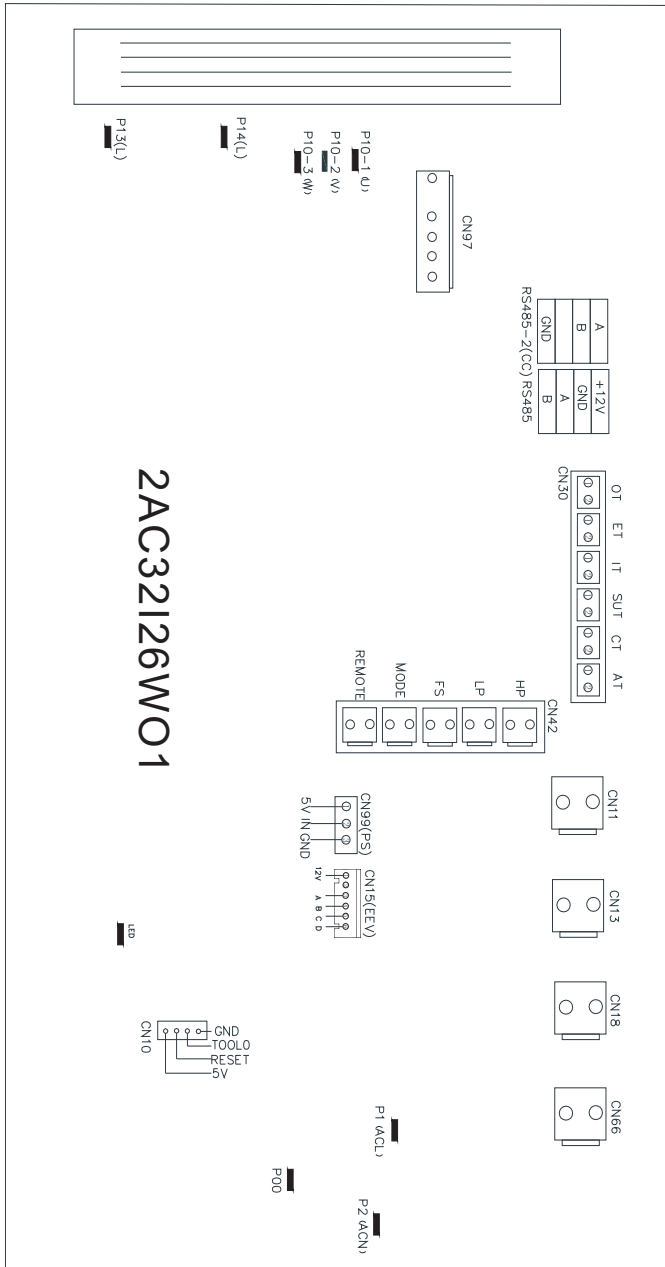

4. Use and Operation Instruction

Main board of the input and output interface instructions below

| Number | Sign | Meaning |
|--------|------------------|-------------------------------------|
| 01 | P10-1/2/3(U/V/W) | Compressor |
| 02 | CN66 | Compressor signal |
| 03 | CN97 | DC motor |
| 04 | CN11 | 4-way valve |
| 05 | CN18 | Water pump |
| 06 | CN13 | reserved |
| 07 | P1 P2 | Live wire Neutral wire |
| 08 | CN10 | Program download interface |
| 09 | RS485 | Color line controller communication |
| 10 | RS485-2 | The port for centralized control |
| 11 | CN15 | Electronic expansion valve |
| 12 | P13(L) | resistance |
| 13 | P14(L) | resistance |
| 14 | HP | System high pressure |
| 15 | LP | System low pressure |
| 16 | FS | Water flow switch |
| 17 | MODE | Mode switch |
| 18 | REMOTE | Emergency switch |
| 19 | IT | Water input temperature |
| 20 | SUT | System suction temperature |
| 21 | CT | System fan coil temperature |
| 22 | OT | Water output temperature |
| 23 | ET | System Exhaust temperature |
| 24 | AT | Ambient temperature |
| 25 | CN99 | Low pressure sensor |

5. MAINTENANCE AND INSPECTION

- Check the water supply device and the release often. You should avoid the condition of no water or air entering into system, as this will influence unit's performance and reliability. You should clear the pool/spa filter regularly to avoid damage to the unit as a result of the dirty or clogged filter.
- The area around the unit should be dry, clean and well ventilated. Clean the side heating exchanger regularly to maintain good heat exchange as conserve energy .
- The operation pressure of the refrigerant system should only be serviced by a certified technician .
- Check the power supply and cable connection often,.Should the unit begin to operate abnormally, switch it off and contact the qualified technician.
- Discharge all water in the water pump and water system ,so that freezing of the water in the pump or water system does not occur. You should discharge the water at the bottom of water pump if the unit will not be used for an extended period of time. You should check the unit thoroughly and fill the system with water fully before using it for the first time after a prolonged period of no usage.
- Checks to the area
Prior to beginning work on systems containing flammable refrigerants, safety checks are necessary to ensure that the risk of ignition is minimised. For repair to the refrigerating system, the following precautions shall be complied with prior to conducting work on the system.
- Work procedure
Work shall be undertaken under a controlled procedure so as to minimise the risk of a flammable gas or vapour being present while the work is being performed.
- General work area
All maintenance staff and others working in the local area shall be instructed on the nature of work being carried out. Work in confined spaces shall be avoided. The area around the workspace shall be sectioned off. Ensure that the conditions within the area have been made safe by control of flammable material.
- Checking for presence of refrigerant
The area shall be checked with an appropriate refrigerant detector prior to and during work, to ensure the technician is aware of potentially flammable atmospheres. Ensure that the leak detection equipment being used is suitable for use with flammable refrigerants, i.e. non-sparking, adequately sealed or intrinsically safe.
- Presence of fire extinguisher
If any hot work is to be conducted on the refrigeration equipment or any associated parts, appropriate fire extinguishing equipment shall be available to hand. Have a dry powder or CO2 fire extinguisher adjacent to the charging area.

5. MAINTENANCE AND INSPECTION

● No ignition sources

No person carrying out work in relation to a refrigeration system which involves exposing any pipe work that contains or has contained flammable refrigerant shall use any sources of ignition in such a manner that it may lead to the risk of fire or explosion. All possible ignition sources, including cigarette smoking, should be kept sufficiently far away from the site of installation, repairing, removing and disposal, during which flammable refrigerant can possibly be released to the surrounding space. Prior to work taking place, the area around the equipment is to be surveyed to make sure that there are no flammable hazards or ignition risks. “No Smoking” signs shall be displayed.

● Ventilated area

Ensure that the area is in the open or that it is adequately ventilated before breaking into the system or conducting any hot work. A degree of ventilation shall continue during the period that the work is carried out. The ventilation should safely disperse any released refrigerant and preferably expel it externally into the atmosphere.

● Checks to the refrigeration equipment

Where electrical components are being changed, they shall be fit for the purpose and to the correct specification. At all times the manufacturer's maintenance and service guidelines shall be followed. If in doubt consult the manufacturer's technical department for assistance.

The following checks shall be applied to installations using flammable refrigerants:

The charge size is in accordance with the room size within which the refrigerant containing parts are installed;

The ventilation machinery and outlets are operating adequately and are not obstructed;

If an indirect refrigerating circuit is being used, the secondary circuit shall be checked for the presence of refrigerant;

Marking to the equipment continues to be visible and legible. Markings and signs that are illegible shall be corrected;

Refrigeration pipe or components are installed in a position where they are unlikely to be exposed to any substance which may corrode refrigerant containing components, unless the components are constructed of materials which are inherently resistant to being corroded or are suitably protected against being so corroded.

● Checks to electrical devices

Repair and maintenance to electrical components shall include initial safety checks and component inspection procedures. If a fault exists that could compromise safety, then no electrical supply shall be connected to the circuit until it is satisfactorily dealt with. If the fault cannot be corrected immediately but it is necessary to continue operation, an adequate temporary solution shall be used. This shall be reported to the owner of the equipment so all parties are advised.

Initial safety checks shall include:

. That capacitors are discharged: this shall be done in a safe manner to avoid possibility of sparking;

. That there no live electrical components and wiring are exposed while charging, recovering or purging the system;

. That there is continuity of earth bonding.

5. MAINTENANCE AND INSPECTION

● Repairs to sealed components

1) During repairs to sealed components, all electrical supplies shall be disconnected from the equipment being worked upon prior to any removal of sealed covers, etc. If it is absolutely necessary to have an electrical supply to equipment during servicing, then a permanently operating form of leak detection shall be located at the most critical point to warn of a potentially hazardous situation.

2) Particular attention shall be paid to the following to ensure that by working on electrical components, the casing is not altered in such a way that the level of protection is affected. This shall include damage to cables, excessive number of connections, terminals not made to original specification, damage to seals, incorrect fitting of glands, etc.

● Ensure that apparatus is mounted securely.

Ensure that seals or sealing materials have not degraded such that they no longer serve the purpose of preventing the ingress of flammable atmospheres. Replacement parts shall be in accordance with the manufacturer's specifications.

NOTE: The use of silicon sealant may inhibit the effectiveness of some types of leak detection equipment. Intrinsically safe components do not have to be isolated prior to working on them.

● Repair to intrinsically safe components

Do not apply any permanent inductive or capacitance loads to the circuit without ensuring that this will not exceed the permissible voltage and current permitted for the equipment in use.

Intrinsically safe components are the only types that can be worked on while live in the presence of a flammable atmosphere. The test apparatus shall be at the correct rating. Replace components only with parts specified by the manufacturer. Other parts may result in the ignition of refrigerant in the atmosphere from a leak.

● Cabling

Check that cabling will not be subject to wear, corrosion, excessive pressure, vibration, sharp edges or any other adverse environmental effects. The check shall also take into account the effects of aging or continual vibration from sources such as compressors or fans.

● Detection of flammable refrigerants

Under no circumstances shall potential sources of ignition be used in the searching for or detection of refrigerant leaks. A halide torch (or any other detector using a naked flame) shall not be used.

● Leak detection methods

The following leak detection methods are deemed acceptable for systems containing flammable refrigerants.

Electronic leak detectors shall be used to detect flammable refrigerants, but the sensitivity may not be adequate, or may need re-calibration. (Detection equipment shall be calibrated in a refrigerant-free area.) Ensure that the detector is not a potential source of ignition and is suitable for the refrigerant used. Leak detection equipment shall be set at a percentage of the LFL of the refrigerant and shall be calibrated to the refrigerant employed and the appropriate percentage of gas (25 % maximum) is confirmed.

Leak detection fluids are suitable for use with most refrigerants but the use of detergents containing chlorine shall be avoided as the chlorine may react with the refrigerant and corrode the copper pipe-work.

If a leak is suspected, all naked flames shall be removed/ extinguished.

If a leakage of refrigerant is found which requires brazing, all of the refrigerant shall be recovered from the system, or isolated (by means of shut off valves) in a part of the system remote from the leak. Oxygen free nitrogen (OFN) shall then be purged through the system both before and during the brazing process.

5. MAINTENANCE AND INSPECTION

● Removal and evacuation

When breaking into the refrigerant circuit to make repairs or for any other purpose conventional procedures shall be used. However, it is important that best practice is followed since flammability is a consideration. The following procedure shall be adhered to:

- . Remove refrigerant;
- . Purge the circuit with inert gas;
- . Evacuate;
- . Purge again with inert gas;
- . Open the circuit by cutting or brazing.

The refrigerant charge shall be recovered into the correct recovery cylinders. The system shall be "flushed" with OFN to render the unit safe. This process may need to be repeated several times. Compressed air or oxygen shall not be used for this task. Flushing shall be achieved by breaking the vacuum in the system with OFN and continuing to fill until the working pressure is achieved, then venting to atmosphere, and finally pulling down to a vacuum. This process shall be repeated until no refrigerant is within the system. When the final OFN charge is used, the system shall be vented down to atmospheric pressure to enable work to take place. This operation is absolutely vital if brazing operations on the pipe-work are to take place. Ensure that the outlet for the vacuum pump is not close to any ignition sources and there is ventilation available. working on them.

● Labelling

Equipment shall be labelled stating that it has been de-commissioned and emptied of refrigerant. The label shall be dated and signed. Ensure that there are labels on the equipment stating the equipment contains flammable refrigerant.

● Recovery

When removing refrigerant from a system, either for servicing or decommissioning, it is recommended good practice that all refrigerants are removed safely.

When transferring refrigerant into cylinders, ensure that only appropriate refrigerant recovery cylinders are employed. Ensure that the correct number of cylinders for holding the total system charge is available. All cylinders to be used are designated for the recovered refrigerant and labelled for that refrigerant (i.e. special cylinders for the recovery of refrigerant). Cylinders shall be complete with pressure relief valve and associated shut-off valves in good working order. Empty recovery cylinders are evacuated and, if possible, cooled before recovery occurs.

The recovery equipment shall be in good working order with a set of instructions concerning the equipment that is at hand and shall be suitable for the recovery of flammable refrigerants. In addition, a set of calibrated weighing scales shall be available and in good working order. Hoses shall be complete with leak-free disconnect couplings and in good condition. Before using the recovery machine, check that it is in satisfactory working order, has been properly maintained and that any associated electrical components are sealed to prevent ignition in the event of a refrigerant release. Consult manufacturer if in doubt.

The recovered refrigerant shall be returned to the refrigerant supplier in the correct recovery cylinder, and the relevant Waste Transfer Note arranged. Do not mix refrigerants in recovery units and especially not in cylinders.

If compressors or compressor oils are to be removed, ensure that they have been evacuated to an acceptable level to make certain that flammable refrigerant does not remain within the lubricant. The evacuation process shall be carried out prior to returning the compressor to the suppliers. Only electric heating to the compressor body shall be employed to accelerate this process. When oil is drained from a system, it shall be carried out safely.

5. MAINTENANCE AND INSPECTION

● Decommissioning

Before carrying out this procedure, it is essential that the technician is completely familiar with the equipment and all its detail. It is recommended good practice that all refrigerants are recovered safely. Prior to the task being carried out, an oil and refrigerant sample shall be taken in case analysis is required prior to re-use of reclaimed refrigerant. It is essential that electrical power is available before the task is commenced.

a) Become familiar with the equipment and its operation.

b) Isolate system electrically.

c) Before attempting the procedure ensure that:

. Mechanical handling equipment is available, if required, for handling refrigerant cylinders;

. All personal protective equipment is available and being used correctly;

. The recovery process is supervised at all times by a competent person;

. Recovery equipment and cylinders conform to the appropriate standards.

d) Pump down refrigerant system, if possible.

e) If a vacuum is not possible, make a manifold so that refrigerant can be removed from various parts of the system.

f) Make sure that cylinder is situated on the scales before recovery takes place.

g) Start the recovery machine and operate in accordance with manufacturer's instructions.

h) Do not overfill cylinders. (No more than 80 % volume liquid charge).

i) Do not exceed the maximum working pressure of the cylinder, even temporarily.

j) When the cylinders have been filled correctly and the process completed, make sure that the cylinders and the equipment are removed from site promptly and all isolation valves on the equipment are closed off.

k) Recovered refrigerant shall not be charged into another refrigeration system unless it has been cleaned and checked.

● Charging procedures

In addition to conventional charging procedures, the following requirements shall be followed.

- Ensure that contamination of different refrigerants does not occur when using charging equipment. Hoses or lines shall be as short as possible to minimise the amount of refrigerant contained in them.

- Cylinders shall be kept upright.

- Ensure that the refrigeration system is earthed prior to charging the system with refrigerant.

- Label the system when charging is complete (if not already).

- Extreme care shall be taken not to overfill the refrigeration system.

Prior to recharging the system it shall be pressure tested with OFN. The system shall be leak tested on completion of charging but prior to commissioning. A follow up leak test shall be carried out prior to leaving the site.

● The safety wire model is 5*20_5A/250VAC, And must meet the explosion-proof requirements

6.APPENDIX

6.1 Cable specification

(1) Single phase unit

| Nameplate maximum current | Phase line | Earth line | MCB | Creepage protector | Signal line |
|---------------------------|----------------------|--------------------|------|------------------------|----------------------|
| No more than 10A | 2×1.5mm ² | 1.5mm ² | 20A | 30mA less than 0.1 sec | n×0.5mm ² |
| 10~16A | 2×2.5mm ² | 2.5mm ² | 32A | 30mA less than 0.1 sec | |
| 16~25A | 2×4mm ² | 4mm ² | 40A | 30mA less than 0.1 sec | |
| 25~32A | 2×6mm ² | 6mm ² | 40A | 30mA less than 0.1 sec | |
| 32~40A | 2×10mm ² | 10mm ² | 63A | 30mA less than 0.1 sec | |
| 40~63A | 2×16mm ² | 16mm ² | 80A | 30mA less than 0.1 sec | |
| 63~75A | 2×25mm ² | 25mm ² | 100A | 30mA less than 0.1 sec | |
| 75~101A | 2×25mm ² | 25mm ² | 125A | 30mA less than 0.1 sec | |
| 101~123A | 2×35mm ² | 35mm ² | 160A | 30mA less than 0.1 sec | |
| 123~148A | 2×50mm ² | 50mm ² | 225A | 30mA less than 0.1 sec | |
| 148~186A | 2×70mm ² | 70mm ² | 250A | 30mA less than 0.1 sec | |
| 186~224A | 2×95mm ² | 95mm ² | 280A | 30mA less than 0.1 sec | |

(2) Three phase unit

| Nameplate maximum current | Phase line | Earth line | MCB | Creepage protector | Signal line |
|---------------------------|----------------------|--------------------|------|------------------------|----------------------|
| No more than 10A | 3×1.5mm ² | 1.5mm ² | 20A | 30mA less than 0.1 sec | n×0.5mm ² |
| 10~16A | 3×2.5mm ² | 2.5mm ² | 32A | 30mA less than 0.1 sec | |
| 16~25A | 3×4mm ² | 4mm ² | 40A | 30mA less than 0.1 sec | |
| 25~32A | 3×6mm ² | 6mm ² | 40A | 30mA less than 0.1 sec | |
| 32~40A | 3×10mm ² | 10mm ² | 63A | 30mA less than 0.1 sec | |
| 40~63A | 3×16mm ² | 16mm ² | 80A | 30mA less than 0.1 sec | |
| 63~75A | 3×25mm ² | 25mm ² | 100A | 30mA less than 0.1 sec | |
| 75~101A | 3×25mm ² | 25mm ² | 125A | 30mA less than 0.1 sec | |
| 101~123A | 3×35mm ² | 35mm ² | 160A | 30mA less than 0.1 sec | |
| 123~148A | 3×50mm ² | 50mm ² | 225A | 30mA less than 0.1 sec | |
| 148~186A | 3×70mm ² | 70mm ² | 250A | 30mA less than 0.1 sec | |
| 186~224A | 3×95mm ² | 95mm ² | 280A | 30mA less than 0.1 sec | |

When the unit will be installed at outdoor, please use the cable which can against UV.

6.APPENDIX

6.2 Comparison table of refrigerant saturation temperature

| | | | | | | | | | | |
|-------------------------|-------|------|------|------|-----|-----|-----|------|------|------|
| Pressure (MPa) | 0 | 0.3 | 0.5 | 0.8 | 1 | 1.3 | 1.5 | 1.8 | 2 | 2.3 |
| Temperature (R410A)(°C) | -51.3 | -20 | -9 | 4 | 11 | 19 | 24 | 31 | 35 | 39 |
| Temperature (R32)(°C) | -52.5 | -20 | -9 | 3.5 | 10 | 18 | 23 | 29.5 | 33.3 | 38.7 |
| Pressure (MPa) | 2.5 | 2.8 | 3 | 3.3 | 3.5 | 3.8 | 4 | 4.5 | 5 | 5.5 |
| Temperature (R410A)(°C) | 43 | 47 | 51 | 55 | 57 | 61 | 64 | 70 | 74 | 80 |
| Temperature (R32)(°C) | 42 | 46.5 | 49.5 | 53.5 | 56 | 60 | 62 | 67.5 | 72.5 | 77.4 |

